

BIN UNLOADING SYSTEMS

SWEEP OPTIONS

Standard Klean Sweep
Commercial Klean Sweep
Standard Power Sweep
Commercial Power Sweep
NexGen Sweep

UNLOADING OPTIONS

Standard Auger Unload
Commercial Auger Unload
U-Trough
Mass-Ter Mover®
Mass-Ter Flow®
Grain Pump™

POWER HEAD DRIVES

Horizontal Tube
Angled Tube
Vertical Tube
Mass-Ter Mover®
Mass-Ter Flow®



Quality Equipment on Your Farm

AGI Hutchinson manufactures quality products, including; portable and stationary grain handling equipment, augers, chain & paddle conveyors, belt conveyors, loop systems, bin unloads and custom augers.



Extended Wear Bin Unloading Package



EW Flight and Collar

'EW' Bin Unloading Package

AGI Hutchinson offers an upgrade package for standard and commercial bin unload systems that greatly enhance flighting life in extreme conditions. The package includes:

- Two revolutions of AR flight at the center well on the unload flight
- One revolution of AR flight at the discharge end of the unload flight
- ¼" flight on under-bin augers
- ⅜" flight on horizontal power heads
- ¼" and AR sectional flight on sweeps
- ¼" and AR sectional flight on verticals
- ¼" and AR sectional flight on 25° unload systems and VAAC

In 25° and variable angle unload systems, a separate flighted U-joint collar is utilized in the transition. The flighted U-joint collar pulls grain through the transition resulting in:

- Improved capacity
- Extended life of the unload flight
- Extended life of the U-joint
- Extended life of the incline flight
- Serviceable and replaceable

AFTER 20,000 BUSHELS OF GRAIN

EXCLUDES 6° SYSTEMS, STANDARD VERTICAL UNLOAD AND STANDARD TORQUE ARM SWEEP

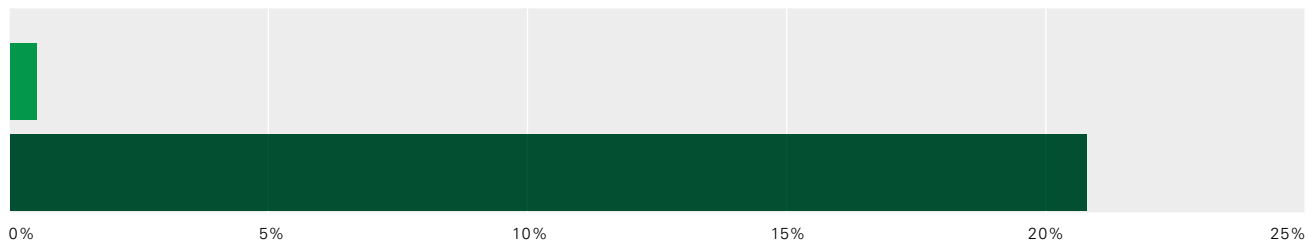

Tested in rice with 25° bin unloads

EW FLIGHT WEAR	0.625%
STANDARD FLIGHT WEAR	21%

Standard Klean Sweep

This simple, easy to handle sweep provides an inexpensive tool for emptying bins up to 48' (14.6 M) diameter. The unique back-shield and torque tube combination adjusts for close floor clearance to maximize bin cleanup. After one or two revolutions of the sweep, the job is done.

FEATURES

- Rubber disk end-wheel assembly drives sweep around the bin
- Intermediate flight bearings on 30' (9.1 M) diameter bins and larger
- Drive includes driven sheave, belt and simplistic motor mount
- 10" units have intermediate bronze bearings that support the flight every 10' (3.1 M) or less



STANDARD KLEAN SPECIFICATIONS

SWEEP MODEL	BIN DIAMETERS	FLIGHT DIAMETER	FLIGHT STRIP	FLIGHT SPEED	CAPACITY
6"	15' (4.6 M) TO 36' (11.0 M)	4" (10.2 CM)	1/8" (3.0 MM)	625 RPM	650 BPH (18 TPH)
8"	15' (4.6 M) TO 48' (14.6 M)	5" (12.7 CM)	1/8" (3.0 MM)	525 RPM	1,175 BPH (32 TPH)
10"	24' (7.3 M) TO 48' (14.6 M)	7" (17.8 CM)	3/16" (4.6 MM)	438 RPM	2,200 BPH (59 TPH)

Sweep End-Wheel

- 8.5:1 reduction inside the wheel, reducing the distance from the sweep auger to the bin wall on sweeps
- Polyurethane treads break up compacted grain and dig down to the bin floor to maintain a driving force into the grain pile
- Aggressive tread design pulls grain from the bin wall into the sweep
- Each wheel is self lubricated and sealed for life
- Retrofit kits available for most 8" and 10" Klean Sweep and Power Sweeps
- Designed, fabricated and assembled in the U.S.A.



CUSTOMER TESTIMONIALS

"The sweep moves ahead on its own. We are able to operate the sweep without having a man in the bin. We've used it in corn and soybeans, and I would never put a sweep in unless it has the new Sweep End Wheel. It's saved us time and money when emptying our 60' grain bins."

- Cogdill Farms, Iowa

"I call it a miracle."

- Byrne Farms, Louisiana



Install the new retro fits kit for your old 8" and 10" Klean Sweep in under 15 minutes



4 piece modular design allows for easy tread replacements without removing the gearbox

Commercial Klean Sweep

AGI Hutchinson's Commercial Klean Sweep is an outstanding performer for a minimal investment. These sweeps provide an economical solution for bin diameters up to 120' (36.6 M).

FEATURES

- 8.5:1 reduction on 810 and 1012 models
- Sweep tractor drive is standard for 1214 models (optional on 1012 models)
- Intermediate flight bearings every 10' (3.1 M) or less running length of flight
- Sweep carrier design provides extra support for flight in 48' (14.6 M) or larger bins on 810 and 1012 models
- The 1214 models provide a sweep carrier in 68' (20.7 M) or larger bins
- The 810 and 1012 Series Sweeps have been redesigned with a 2.25:1 double gearbox drive to position the sweep closer to the bin floor



Splice Plate for added strength



Double gearbox to get the sweep lower to the bin floor



RetroFit Kits available for 810 and 1012 models

COMMERCIAL KLEAN SWEEP SPECIFICATIONS

SWEEP MODEL	BIN DIAMETERS	FLIGHT DIAMETER	FLIGHT STRIP	FLIGHT SPEED	CAPACITY
810	24' (7.3 M) - 92' (28.0 M)	7" (17.7 CM)	1/4" (4.6 MM)	300-400 RPM	1,600-2,050 BPH (43-55 TPH)
1012	24' (7.3 M) - 113' (34.44 M)	9" (22.9 CM)	1/4" (4.6 MM)	250-290 RPM	3,200-3,700 BPH (86-100 TPH)
1214	36' (11.0 M) - 120' (36.6 M)	12" (30.5 CM)	1/4" (4.6 MM)	150-230 RPM	3,950-6,100 BPH (106-165 TPH)

Standard & Heavy Duty Power Sweep

The Power Sweep provides the convenience of powering both the unloading flight and the sweep with one motor on the outside of the grain bin. The sweep can remain inside the bin during the grain bin filling process, allowing it to be in position for use at a moment's notice. We have an excellent choice of power head options to fit your application that will complete your unloading system.

FEATURES

- Center power well and roller supported gate with gearboxes
- Sweep end-wheel has an 8.5:1 reduction
- Underbin auger housing and flight
- Appropriate number of intermediate wells
- Control pipe kit with unique control lever for maximum pull
- Sweep carrier design for bins over 48" diameter
- Secondary center wells upon request



Reduced shaft to get sweep closer to the bin floor



New splice plate for added strength



8" and 10" RetroFit Kits available

STANDARD & HEAVY-DUTY POWER SWEEP SPECIFICATIONS

AUGER UNLOAD MODEL	BIN DIAMETERS	SWEEP FLIGHT DIAMETER	UNLOAD FLIGHT DIAMETER	SWEEP FLIGHT STRIP	UNLOAD FLIGHT STRIP	FLIGHT SPEED	CAPACITY
6" STANDARD	15' (4.6 M) - 48' (14.6 M)	7" (17.8 CM)	5" (12.7 CM)	1/8" (3.0 MM)	1/8" (3.0 MM)	450-525 RPM	1,000-1,200 BPH (27-32 TPH)
8" STANDARD	15' (4.6 M) - 48' (14.6 M)	7" (17.8 CM)	7" (17.8 CM)	3/16" (4.6 MM)	3/16" (4.6 MM)	325-440 RPM	1,700-2,200 BPH (46-59 TPH)
10" STANDARD	24' (7.3 M) - 48' (14.6 M)	7" (17.8 CM)	9" (22.9 CM)	3/16" (4.6 MM)	3/16" (4.6 MM)	325-440 RPM	3,575-4,500 BPH (96-122 TPH)
8" HEAVY DUTY	30' (9.1 M) - 72' (22.0 M)	7" (17.8 CM)	7" (17.8 CM)	3/16" (4.6 MM)	1/4" (6.4 MM)	325-440 RPM	1,700-2,200 BPH (46-59 TPH)
10" HEAVY DUTY	30' (9.1 M) - 78' (23.77 M)	7" (17.8 CM)	9" (22.9 CM)	3/16" (4.6 MM)	1/4" (6.4 MM)	325-440 RPM	3,575-4,500 BPH (96-122 TPH)

Commercial Power Sweep

The Commercial Power Sweep is a unique concept adapted to commercial type storage. This sweep will accommodate a variety of unloading units, including; auger unloaders, U-Trough, chain conveyors and grain pump loop systems. Like our other power sweep, it offers the convenience of having the drive on the outside of the bin, but with the added feature of using a separate drive for the sweep. We have the drive necessary to complement the unloading system that you choose.

FEATURES

- Two individual gearboxes allow compact design for center well
- End wheel has an 8.5:1 reduction drive
- Intermediate wells provided with removable top flanges for easier installation
- Sweep carrier provides extra support for flight and shield for sweeps in 48' (14.6 M) or larger bins
- Control pipe kits with rack and pinion style openers
- Drive shaft has 1" flange bearings on 5' centers



Retro fit kits available for all sizes



COMMERCIAL POWER SWEEP SPECIFICATIONS

SWEEP MODEL	BIN DIAMETERS	FLIGHT DIAMETER	FLIGHT STRIP	FLIGHT SPEED	CAPACITY
600	36' (11.0 M) to 60' (18.3 M)	7" (17.7 CM)	3/16" (4.6 MM)	300-400 RPM	1,600-2,050 BPH (43-55 TPH)
800	36' (11.0 M) to 60' (18.3 M)	9" (22.9 CM)	1/4" (6.4 MM)	220-250 RPM	2,800-3,200 BPH (76-86 TPH)
1000	36' (11.0 M) to 75' (22.9 M)	9" (22.9 CM)	1/4" (6.4 MM)	300-325 RPM	3,850-4,150 BPH (104-112 TPH)
1200	36' (11.0 M) to 75' (22.9 M)	9" (22.9 CM)	1/4" (6.4 MM)	375-395 RPM	4,800-5,050 BPH (130-136 TPH)

NexGen Commercial Sweep

FEATURES

- Built to remain in the bin
- Sturdy construction to withstand years of heavy use
- Modular design allows adaptation to bin diameters from 36'-156' (11 M - 47.6 M)
- Control box provides both total automation and manual operation
- Optional Tru-Klean drag floats across the bin floor providing a near broom sweep

12-1/2" (31.8 CM) O.D. Flight



Control Box Option

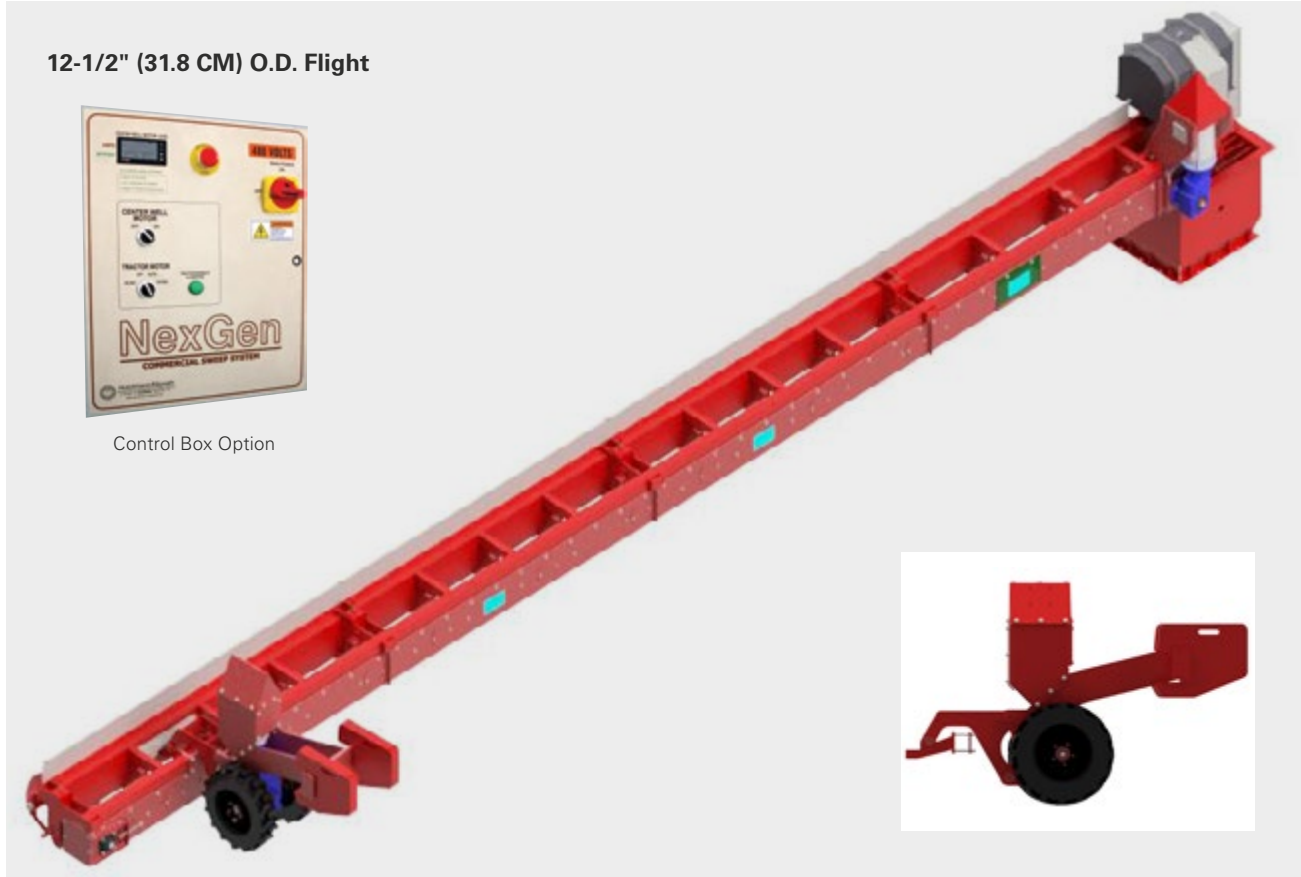

NEXGEN COMMERCIAL SWEEP SPECIFICATIONS

NEXGEN MODEL	CAPACITIES	FLIGHTING	DRIVE	TRACTOR	CENTER WELL OPTION	CONTROL BOX OPTION
2000	6,500 - 8,500 BPH (175 - 203 TPH)	12.5" (31.8 CM) O.D. x 1/4" (6 MM) thick	4:1 Gear Reducer drive up to 40 HP (30 kW)	Unique 2 wheel direct drive tractor design with a 350:1 reduction gearbox. One tractor up to 92' bin diameters and two tractors on larger bin diameters 105' and larger	30" x 30" (76 cm x 76 CM) opening for both Electric Slip Ring Well or Non-Electrical Well. 42" x 42" Centerwell is an option	Control Box allows automatic control for starting and stopping the tractor determined by the amount of amps being drawn by the motor operating the sweep flight. Also features a tractor reverse option as well as a main "on-off" switch

NexGen 3000 Series Commercial Sweep



MODEL 3150

- 15,000 BPH capacity
- 50,000 BPH free-flowing capacity through centerwell
- Tru-Klean chain & paddle option provides near broom swept finish
- Available for bins 48' to 150' diameter
- Touchscreen control panel

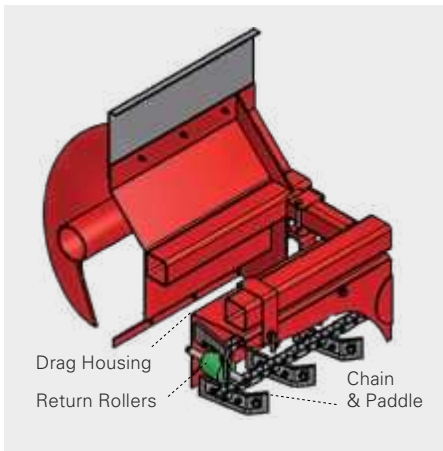

48" x 48" x 18" center well 50,000 BPH free-flow capacity

Optional Tru-Klean Chain & Paddle Sweep

- Chain & paddles float across the floor behind the sweep
- Utilizes return rollers for reduced friction
- Drag is powered directly from the sweep auger
- Pulls additional grain into the center well for a near broom swept finish

NEXGEN 3000 SERIES COMMERCIAL SWEEP SPECIFICATIONS

NEXGEN MODEL	CAPACITIES	FLIGHTING	DRIVE	TRACTOR	CENTER WELL OPTION	CONTROL BOX OPTION
3000	7,500 – 15,000 BPH (203 - 406 TPH)	18" (45.7 CM) O.D. x 3/8" (10 MM) thick	13:1 Reducer drive up to 50 HP	Unique 4 wheel direct drive tractor design, one tractor on bin diameters up to 88' and two tractors in diameters 90' to 150'	48" x 48" (122 CM x 122 CM) opening with above floor Electric Slip Ring	Control Box allows automatic control for starting and stopping the tractor determined by the amount of amps being drawn by the motor operating the sweep flight. Also features a tractor reverse option as well as a main "on-off" switch. Includes touch screen controls to allow flight speed control, will display current sweep position

Standard & Commercial Auger Unloading

Using auger unloading housing and flight is an economical approach to storage unloading that has a proven history for reliability. These unloaders can be purchased as a whole unit that includes the unloading tube and flight and the center well, intermediate wells, and control pipe kits. Then with the selection of your choice of power head, you will have a complete unload system. Also, our systems can be ordered as components that will allow you to completely customize what you need for any application.

FEATURES

- Choice of unloading tube and flights to meet your capacity and size requirements
- Various center bin well and intermediate bin well options available
- Control pipe kits and either control lever or rack & pinion openers to select from
- Bin flanges, quick connect flange clamps and an assortment of other possible components to complete your unload system

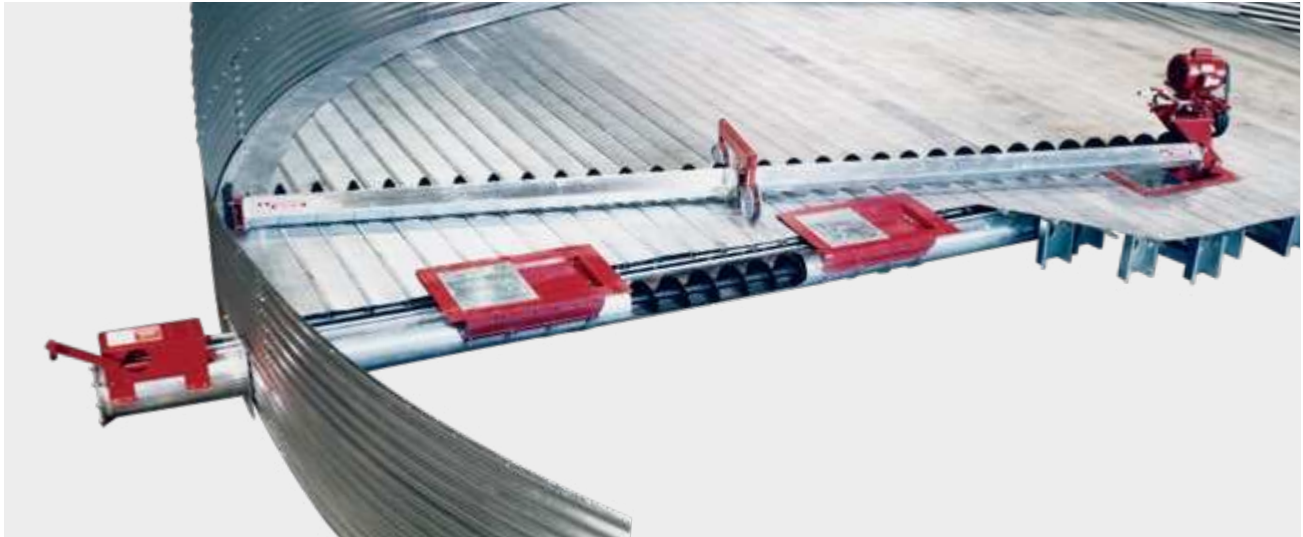

AUGER UNLOADING SPECIFICATIONS

AUGER UNLOAD MODEL	BIN DIAMETERS	UNLOAD TUBE	UNLOAD FLIGHT	FLIGHT SPEED	CAPACITY
6" STANDARD	14' (4.3 M) - 37' (11.3 M)	6" (15.2 CM) O.D. x 12 GA (2.7 MM) Galv.	5" (12.7 CM) O.D. x 1/8" (3.0 MM) thick	525 RPM	1,500 BPH (41 TPH)
8" STANDARD	14' (4.3 M) - 48' (14.6 M)	8" (20.3 CM) O.D. x 12 GA (2.7 MM) Galv.	7" (17.8 CM) O.D. x 1/4" (4.6 MM) thick	440 RPM	2,500 BPH (68 TPH)
10" STANDARD	23' (7.0 M) - 48' (14.6 M)	10" (25.4 CM) O.D. x 12 GA (2.7 MM) Galv.	9" (22.9 CM) O.D. x 1/4" (4.6 MM) thick	440 RPM	4,000 BPH (108 TPH)
8" COMMERCIAL	24' (7.3 M) - 78' (23.8 M)	8" (20.3 CM) O.D. x 12 GA (2.7 MM) Galv.	7" (17.8 cCM) O.D. x 1/4" (6.4 MM) thick	440 RPM	2,500 BPH (68 TPH)
10" COMMERCIAL	24' (7.3 M) - 78' (23.8 M)	10" (25.4 CM) O.D. x 12 GA (2.7 MM) Galv.	9" (22.9 CM) O.D. x 1/4" (6.4 MM) thick	440 RPM	4,000 BPH (108 TPH)
12" COMMERCIAL	24' (7.3 M) - 92' (28.0 M)	12" (30.5 CM) O.D. x 12 GA (2.7 MM) Galv.	11" (27.9 CM) O.D. x 1/4" (6.4 MM) thick	350 RPM	6,300 BPH (170 TPH)
14" COMMERCIAL	36' (11.0 M) - 92' (28.0 M)	14" (35.6 CM) O.D. x 12 GA (2.7 MM) Painted	12 1/2" (31.8 CM) O.D. x 1/4" (6.4 MM) thick	300 RPM	9,400 BPH (254 TPH)

U-Trough Unloading

The U-Trough auger conveyor is a custom design type and a good solution for horizontal applications where extended hours of use are needed. The U-Trough auger has flighting that is supported every 10' (3 M) by hanger bearings inside of a "U" shaped housing and in combination with reduced speed permits minimal wear. These units are put together with a combination of components as opposed to a packaged product to meet your specific demands.

FEATURES

- Hanger bearing choices for the flight is either wood or nylon
- Oil bath chain reducer, 4:1 gear reducer drive or Dodge reducer drives are available
- A galvanized cover for top of conveyor is clamped into place, giving easy access to the auger flighting
- Roller gate wells that are 5 3/4" (14.6 CM) tall along with a three control pipe system for the well gates is used with a rack and pinion style of control to operate the gates



U-TROUGH SPECIFICATIONS

U-TROUGH MODEL	U-TROUGH HOUSING	U-TROUGH FLIGHT	FLIGHT SPEED	CAPACITY
9"	10" (25.4 CM) Wide x 14 GA (1.9 MM) Painted	9" (22.9 CM) O.D. x 3/16" (4.6 MM) or 3/8" (9.5 MM)	80 - 325 RPM	500 - 4,000 BPH (14 - 108 TPH)
12"	13" (33.0 CM) Wide x 12 GA (2.7 MM) Painted	12" (30.5 CM) O.D. x 1/4" (6.4 MM) or 3/8" (9.5 MM)	80 - 260 RPM	1,250 - 8,300 BPH (34 - 224 TPH)

En Masse Conveyors

FEATURES

- Long life of 81 X or 81 XHH roller chain
- Quiet operation and long life of UHMW plastic paddles
- Unquestionable quality of Dodge drives

Mass-Ter Mover® Unload

For horizontal, inclined and even vertical requirements, the Mass-Ter Mover® unload is a versatile system that will maintain its capacity



MASS-TER MOVER® MODEL	MASS-TER MOVER® HOUSING (ZAM)	CONVEYOR CHAIN	CONVEYOR PADDLE	CHAIN SPEED	CAPACITY
50	6" x 9" (15.2 x 22.9 CM) 10 GA (3.4 MM) Bottom	81 X Chain	3/8" (9.5 MM) Thick UHMW	150 - 325 FPM (46 - 99 MPM)	2,500 - 5,000 BPH (68 - 135 TPH)
85	7" x 13" (17.8 x 33 CM) 10 GA (3.4 MM) Bottom	81 XHH Chain	1/2" (12.7 MM) Thick UHMW	150 - 400 FPM (46 - 122 MPM)	4,000 - 10,000 BPH (108 - 270 TPH)
150	10" x 17" (25.4 x 43.2 CM) 10 GA (3.4 MM) Bottom	Double 81 XHH Chain	5/8" (15.9 MM) Thick UHMW	150 - 350 FPM (46 - 107 MPM)	7,500 - 15,000 BPH (203 - 473 TPH)

Mass-Ter Flow® Unload

For horizontal use only, this single trunk design with its low profile paddle is the most economical choice for storage unloading

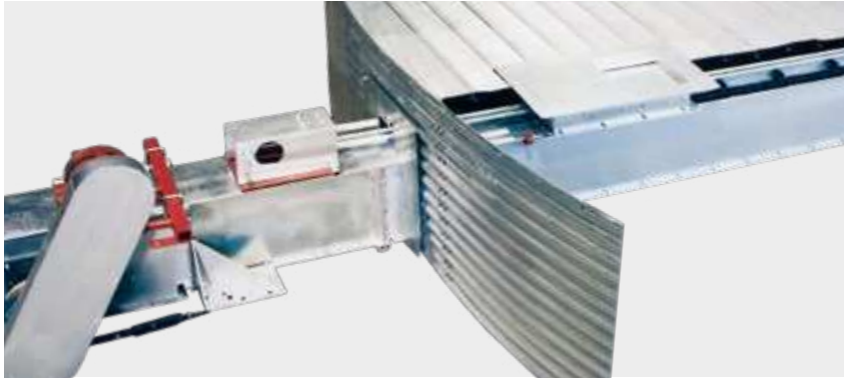

MASS-TER® FLOW MODEL	MASS-TER® FLOW HOUSING	CONVEYOR CHAIN	CONVEYOR PADDLE	CHAIN SPEED	CAPACITY
9"	9" (22.9 CM) - 10 GA (3.4 MM) Bottom	81 x Chain	3/8" (9.5 MM) Thick UHMW	80 - 320 FPM (24 - 98 MPM)	2,500 - 10,000 BPH (68-270 TPH)
13"	13" (33.0 CM) - 10 GA (3.4 MM) Bottom	81 x Chain	3/8" (9.5 MM) Thick UHMW	130 - 260 FPM (40 - 79 MPM)	7,500 - 15,000 BPH (203-405 TPH)

Grain Pump™ Unload

The innovative AGI Hutchinson Grain Pump™ utilizes a round tube and paddle and is capable of doing it all in the simplest of systems. This is not just an unloading conveyor, it can fill your storage or transfer grain from one bin to another

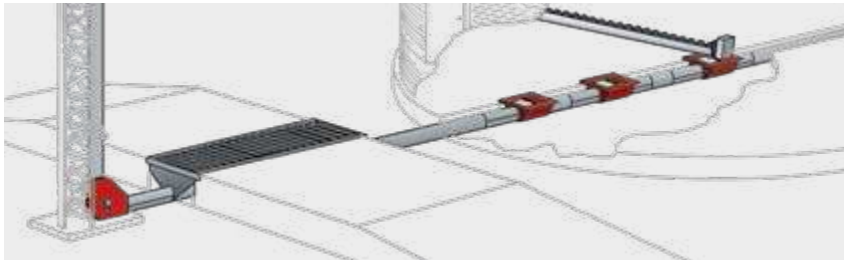

GRAIN PUMP™ MODEL	MASS-TER® MOVER HOUSING (ZAM)	CONVEYOR CHAIN	CONVEYOR PADDLE	CHAIN SPEED	CAPACITY
50	6" x 9" (15.2 x 22.9 CM) 10 GA (3.4 MM) Bottom	81 x Chain	3/8" (9.5 MM) Thick UHMW	150 - 325 FPM (46 - 99 MPM)	2,500 - 5,000 BPH (68 - 135 TPH)
85	7" x 13" (17.8 x 33 CM) 10 GA (3.4 MM) Bottom	81 XHH Chain	1/2" (12.7 MM) Thick UHMW	150 - 400 FPM (46 - 122 MPM)	4,000 - 10,000 BPH (108 - 270 TPH)
150	10" x 17" (25.4 x 43.2 CM) 10 GA (3.4 MM) Bottom	Double 81 XHH Chain	5/8" (15.9 MM) Thick UHMW	150 - 350 FPM (46 - 107 MPM)	7,500 - 15,000 BPH (203 - 473 TPH)

Auger Unloading Power Heads

Horizontal

Horizontals available in

6" (15.2 CM) | **8"** (20.3 CM)

10" (25.4 CM) | **12"** (30.5 CM)

Single and double direct belt drives on units with Standard Components System. Commercial grade furnished with 2, 3 & 4 belt drives, many with oil bath reducers.

Also available: Low-Boy and Variable Angle Auger Connectors (not illustrated). Special length or height power heads available with special drives. Ask for details.

IMPORTANT: Keep all shields and safety devices in place at all times. Observe all safety signs and warnings shown on the product and in the operator's manual.



25° Incline

Horizontals available in

6" (15.2 CM) | **8"** (20.3 CM)

10" (25.4 CM) | **12"** (30.5 CM)

Horizontal Unloading Systems through 90' (27.4 M) diameter bins. Single and double direct belt drives on units with Standard Components System. Commercial Grade furnished with 2, 3 & 4 belt drives, many with oil bath reducers.

5' (1.5 M) length provides about 2' (0.6 M) extra discharge height. Includes adjustable support stand to which you can attach optional wheel kit for portability. Two & three belt "B" section drives. Internal bearing in elbow. Units are offered as 6" (15.2 CM) to 8" (20.3 CM), 8" (20.3 CM) to 10" (25.4 CM), 10" (25.4 CM) to 12" (30.5 CM) and 12" (30.5 CM) to 14" (35.6 CM). We recommend the step-up sizes at all times for maximum capacity and smooth grain flow.



Standard Vertical

8" (20.3 CM), and **10"** (25.4 CM) **verticals stand 16' 6"** (5.0 M) **tall and are used with Standard Components System** on bins through 48" (14.6 M) diameter. Discharge directly into truck, trailer or mill. One drive with heavy right angle oil bath gearbox runs both the vertical and under-bin auger. Electric powered, includes 45° discharge with 3' (0.9 M) long solid spout, base support and bin wall mounting brackets. Kit available to attach 8" (20.3 CM) vertical to 6" (15.2 CM) or 10" (25.4 CM) to 8" (20.3 CM) unload tube.



Commercial Double Drive Vertical

8" (20.3 cm), **10"** (25.4 CM) and **12"** (30.5 CM) **Commercial Grade Verticals stand 16' 6"** (5.0 M) tall. Separate direct belt or 3:1 oil bath reducer drives on horizontal and vertical sections speed-match capacities. This dual drive design will handle 24' (7.3 M) thru 120" (36.6 M) diameter bins. Includes 3' (0.9 M), 45° discharge, base support and wall brackets. Kit available to attach 10" (25.4 CM) unit to 8" (20.3 CM) or 12" (30.5 CM) to 10" (25.4 CM) unload tube.



Mass-Ter Mover® Power Head

The Mass-Ter Mover® unloading power heads can be used in conjunction with 30°, 45°, or 90° corners (15° available on model 50 units) that will provide the discharge height needed. A selection of reducer drives with various chain speeds and horsepower are available to match the capacity required.



Mass-Ter Flow® Power Head

The Mass-Ter Flow® unloading power heads can be ordered with a drive that will complement the length of conveyor necessary to unload your storage structure. These high quality drives provide smooth, quiet power that will give exceptional life to the conveyor.

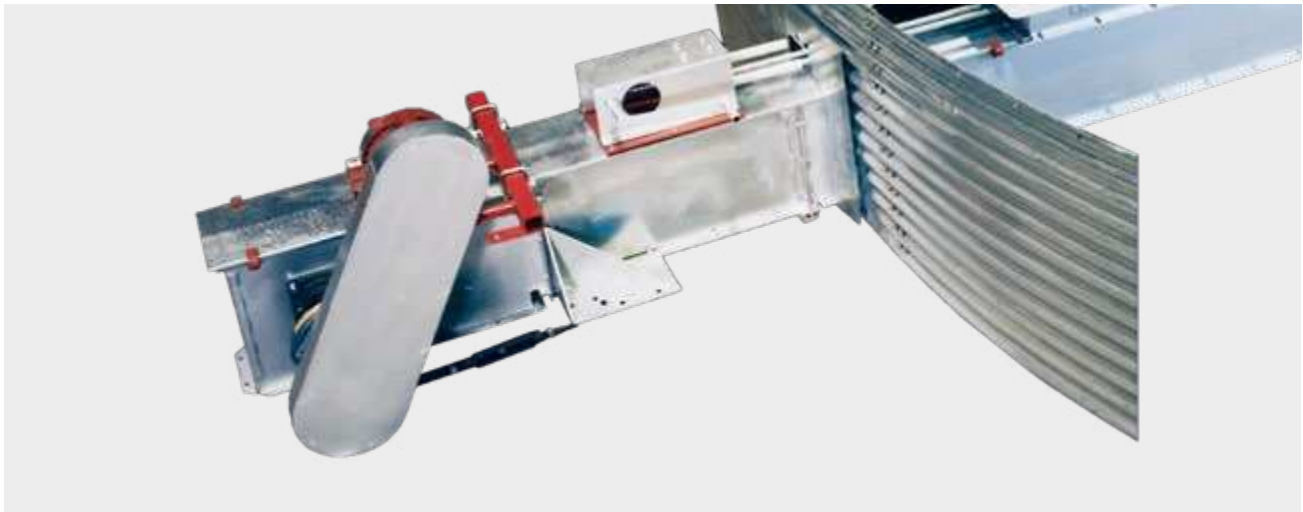



HUTCHINSON is an AGI Brand.

AGI is a leading provider of equipment solutions for agriculture bulk commodities including seed, fertilizer, grain, and feed systems with a growing platform in providing equipment and solutions for food processing facilities. AGI has manufacturing facilities in Canada, the United States, the United Kingdom, Brazil, India and Italy and distributes its products globally.

AGI HUTCHINSON

P.O. Box 629, 74, Clay Center, Kansas, USA 67432

P 785.632.2161 | aggrowth.com/hutchinson

AGGROWTH.COM [aggrowthintl](#) [▶](#) [▶](#) [▶](#) [▶](#) [▶](#) [▶](#) [▶](#) [▶](#) [▶](#) [▶](#)